

THIS DOCUMENT CONTAINS INFORMATION PROPRIETARY TO DELTA MICROWAVE. ANY REPRODUCTION WITHOUT WRITTEN PERMISSION IS EXPRESSLY PROHIBITED.

ZONE	REV	DESCRIPTION	DATE	APPROVED
	A	RELEASED	10/21/02	R.E.S.
	B	ADDED MOUNTING PATTERN	10/23/02	R.E.S.
	C	CHANGED MARKING NOTE TO LABEL	12/13/02	

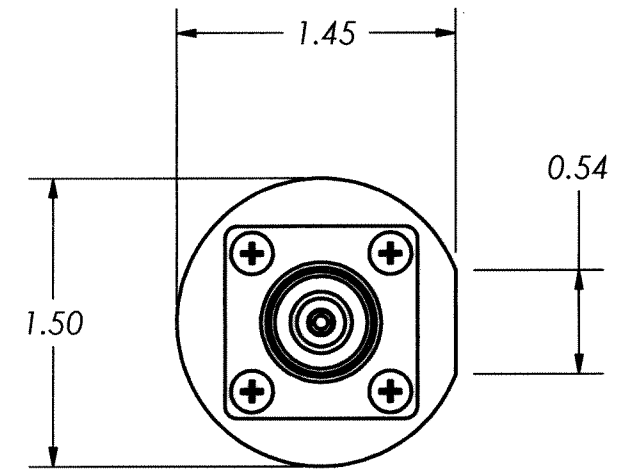
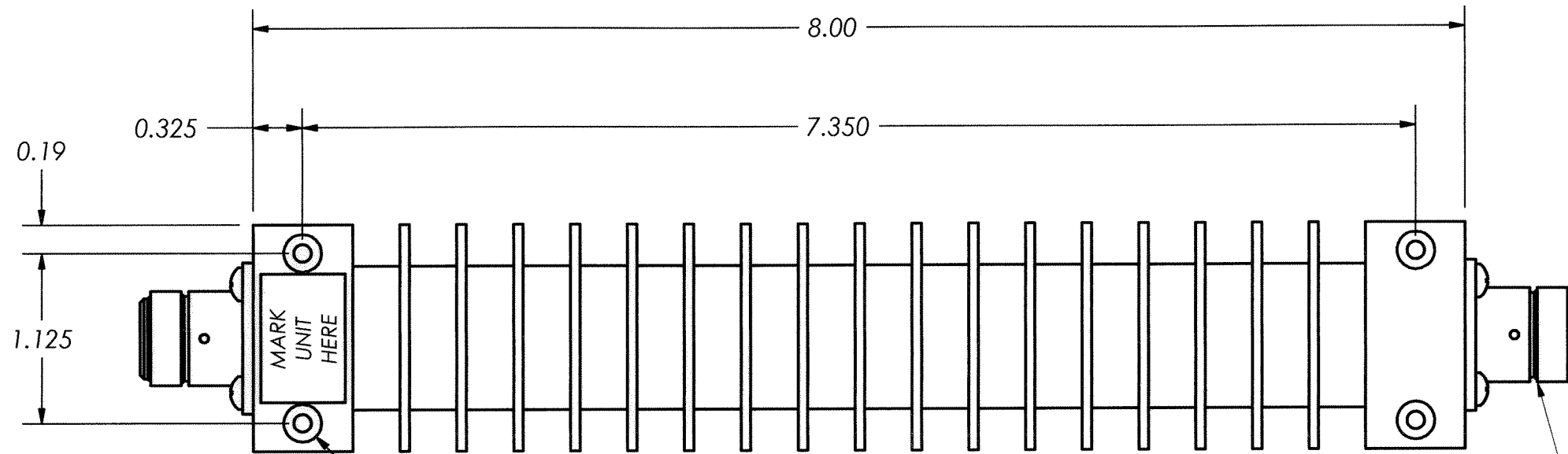

Ø0.116 THRU
 L ∟ Ø0.250 ±0.500
 4 PLACES

TYP "N" FEMALE CONNECTOR
 2 PLACES

2. MARKING: USING BLACK CHARACTORS ON SILVER LABEL TO INCLUDE
 DELTA MICROWAVE, MODEL NO., SERIAL NO.
 CODE IDENT. NO. 51719 AND DATE CODE

1. FINISH: HAZE GRAY EPOXY POLYAMIDE TOPCOAT
 PER MIL-P-24441B TYP. 1
 (AS) COLOR NO. 26270, FORMULA 151
 PER MIL-P-24441/1C, QPL 24441-103
 USING EPOXY POLYAMID PRIMER
 PER MIL-P-2441B TYP. 1 24272 GREEN
 FORMULA 150 PER MIL-P-24441/1C, QPL 24441-103

NOTES:

UNLESS OTHERWISE SPECIFIED DIMENSIONS ARE IN INCHES TOLERANCES ARE: FRACTIONS DECIMALS ANGLES + .xx ± .03 + - .xxx ± .010 -	CONTRACT NO. U3931	DELTA MICROWAVE 1301 VANGUARD DRIVE OXNARD, CA 93033	
	APPROVALS	DATE	TITLE
MATERIAL	DRAWN D.F. ESTABROOK	10/21/02	U3931 OUTLINE
FINISH	CHECKED <i>NCAS</i>	12/13/02	
USED ON MODEL#	DO NOT SCALE DRAWING	SIZE B	CODE IDENT NO. 51719
		SCALE FULL	DWG NO. U3931
		SHEET 1	OF 1